

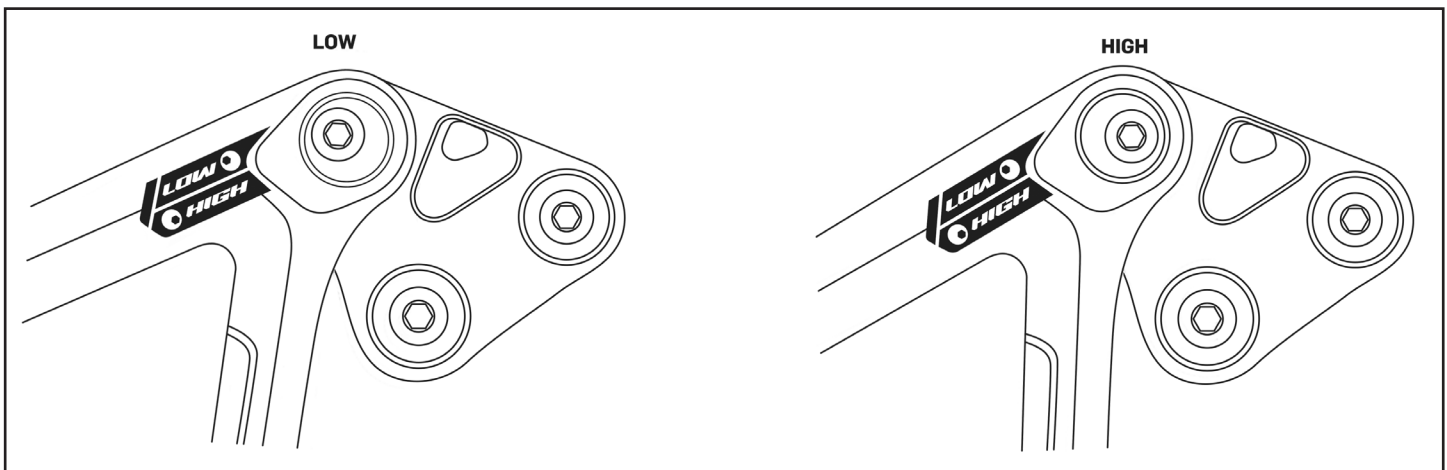

**What is the “flip chip” and when would I want to use it?**

The flip chip is a simple way to adjust the geometry on your bike. It allows you to either adjust the geometry for different trail conditions or can allow for the use of mixed wheel setup as well. For most models the chip comes set up in the low BB setting. This is perfect for riding fast, technical and steep terrain. However, if your preference is for a little more crank clearance and slightly quicker handling for tighter terrain with more climbing and/or roots and rocks, you may prefer the high BB setting. The high BB setting will raise the bottom bracket and steepen the head angle by .5° degree giving the bike faster turn in.

Each frame has a graphic on the rear triangle near the flip chip to show which mode you are in based on the flip chip position.



<b>TABLE OF CONTENTS</b>		<b>PAGE</b>
<b>1. Flip Chip Parts &amp; Trailside Adjustments</b>		<b>1</b>
<b>2. Flip Chip Removal</b>		<b>2</b>
<b>3. Flip Chip Installation</b>		<b>3</b>
<b>4. Flip Chip Service Procedures</b>		<b>4-8</b>





DESCRIPTION	PART NUMBER	QTY	ASSEMBLY
4.6mm Flip Chip	FP-NUT-FLIPCHIP-4.6MM-V1	2	Blue Loctite 243 on threads Grease on frame contacting surfaces
M14x20 Flip Chip Bolt	FP-BLT-M14*20-BLK-V3-R2	2	Torque 35 Nm
M14x3mm Flip Chip Spacer	FP-BLT-M14*20-BLK-V3-R2	2	Grease surfaces
28mm 6902 Standard Max Bearing	FP-BRG-6902-LLUMAX	2	Green Loctite 620 when installing into links

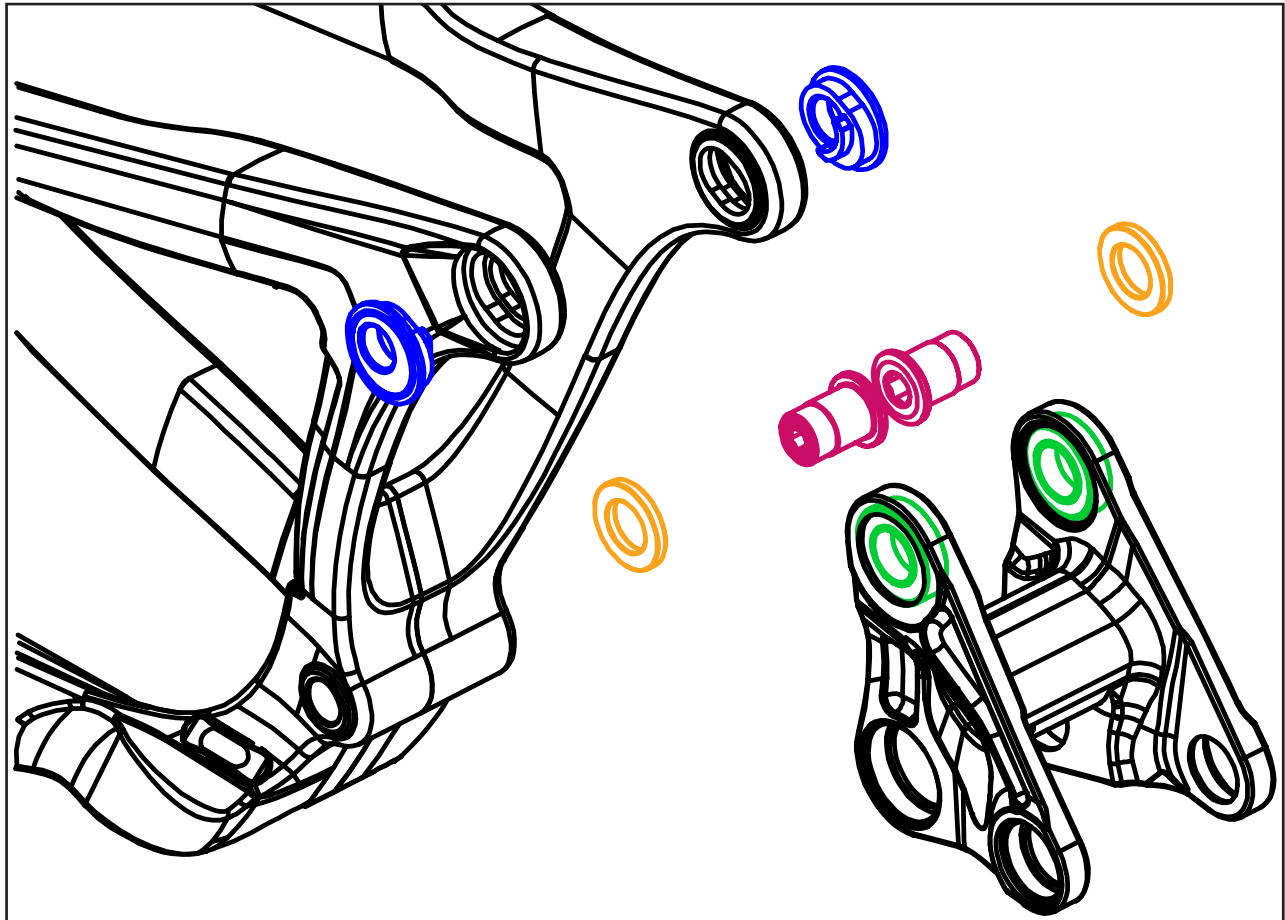

## TRAILSIDE ADJUSTMENTS

If you are looking to change between high and low while out on a ride it is easy. Simply loosen using a 6mm hex wrench. *These bolts are threaded in from the inside of the link so from the outside you need to rotate them clockwise to loosen.*

1. Partially back out the bolts 3-4 rotations– *there is no need to completely remove the chips.* If you do unthread the chip completely no worries, just hold onto it so you don't drop it on the ground.
2. Pull the chips out and rotate them to your desired position. *Pushing on the bolt from inside the link can make it easier to get the chips out far enough to rotate.*
3. Tighten the bolts back down (turning the wrench counter-clockwise) to 35 Nm and check out your bike's new handling and feel.



1. See the frame graphic to reference the flip chip and bolt position for low/high. Note the torque spec and direction of rotation of the bolt to tighten/loosen etched on the bolt.



2. Begin by loosening the flip chip bolts using a 6mm hex wrench. The bolts are inserted from the inside of the link so to loosen them from the outside you will need to rotate the wrench clockwise.

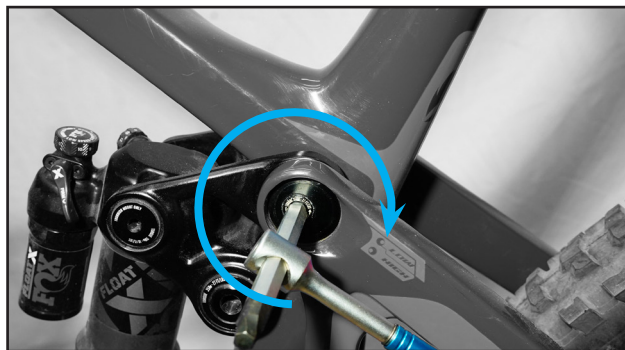

3. Remove the flip chips from both sides. *Pushing on the bolt from inside the link can make it easier to get the chips out. The form of the chip only allows it to go in to the oval pocket two ways.*





1. Position the frame so that the flip chip bolt is in your desired setting. *This can be done with the flip chips loosened and not completely removed.*



2. Align the flip chip with the bolt and begin threading it in by rotating the bolt counter-clockwise. Check that the flip chip is properly aligned in the frame for your chosen riding position. *Do not tighten completely until you have aligned the flip chip on the other side of the bike.*



3. Align and install the flip chip on the other side of the bike.

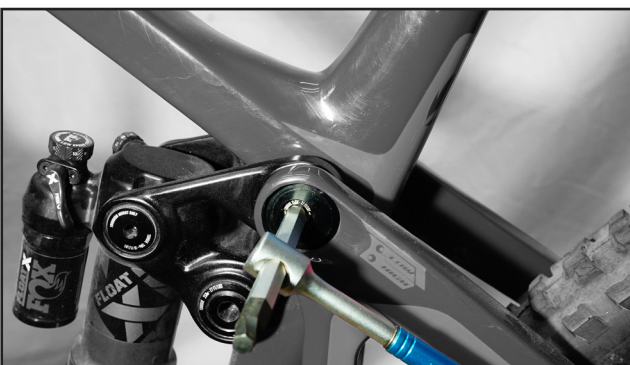

4. Torque both flip chip bolts to 35Nm.



*NOTE: On some models and smaller frame sizes the bolts may line up with the seat tube not allowing the bolts to be removed from the link. In these cases removing the shock so you can rotate the frame forward is required. If the shock does not need to be removed skip to step 7.*

1. Begin by loosening the flip chip bolts a turn or two. This will make it easier to remove them if the shock is removed from the frame.



2. Place a towel or rag on the downtube to protect it when removing the shock.



3. Loosen and remove the two trunnion mounting bolts from the upper link.



4. Loosen and remove the lower shock bolt.



5. Remove the shock from the frame.



6. Lift the rear triangle to rotate the upper link to access the flip chip bolts from the inside.





7. Loosen and remove both flip chips.



8. Loosen and remove the flip chip bolts.



9. Carefully rotate the lower link forward out of the rear triangle to not drop the washers.



10. Remove both flip chip washers.



11. With the chips, bolts, and washers removed clean any residual grease and threadlocker off the surfaces of all the parts. Isopropyl alcohol is recommended to clean all the parts before reassembly.





12. Apply Motorex Bike Grease 2000 or equivalent to the both sides of each washer.



14. Grease the frame contacting surfaces of the flip chip or the flip chip pocket on the frame. *Take care not to get any grease on the threads.*

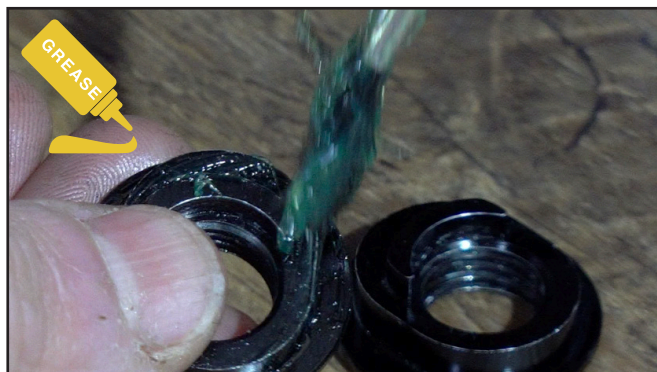

15. Apply Loctite 243 or equivalent to the flip chip threads and spread around with a round wooden toothpick.



16. You can either install the flip chips into the frame pockets or align the link in the rear triangle and insert the bolts. Either method works well, however, we will show the flip chips installed in the frame method in this document.

16. Insert the flip chips into the frame with the hole in the desired flip chip positions

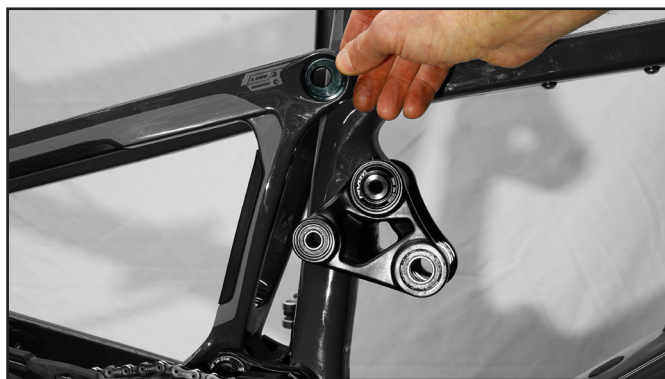

17. Positions the washers on the bearings of the upper link. They should stick in place with the grease.

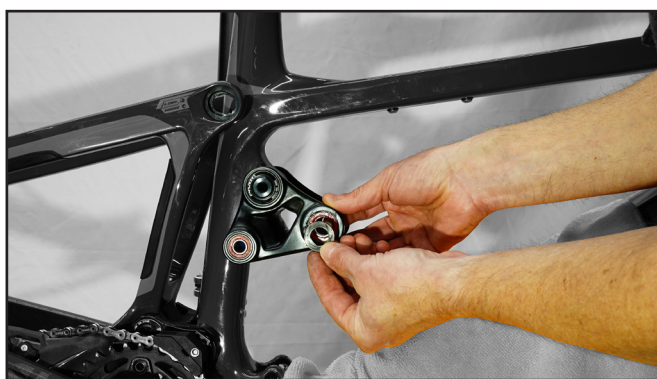



18. Position the upper link in the RT taking care not to drop the washers as it goes into the RT.



19. Insert one of the flip chip bolts through the link and frame and align with the flip chip.



20. Use a 6mm wrench to snug the bolt into the flip chip. Repeat this process on the other side.



21. Torque both flip chip bolts to 35 Nm.



22. Apply a small amount of Loctite 243, or equivalent, to the lower shock frame threads. Spread evenly with a wooden toothpick. *Loctite can damage paints and finishes so use caution.*

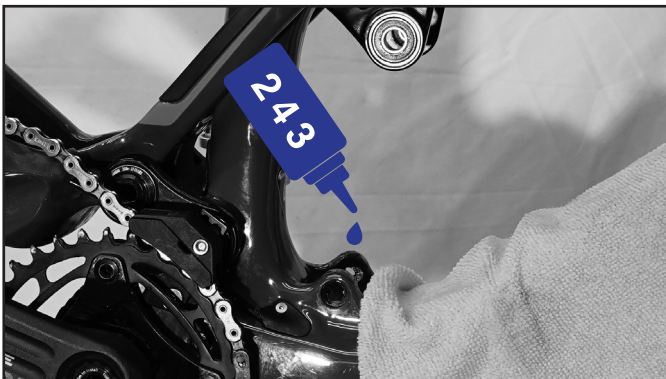

23. Apply a small amount of Loctite 243, or equivalent, to the trunnion mount threads. Spread evenly with a wooden toothpick.







24. Position the shock in the shock tabs to line up the lower shock bolt.



25. Apply Motorex Bike Grease, or equivalent, to the head and shaft of the bolt, but not on the threads.



25. Install the lower shock bolt.



26. Align the upper link with the shock and install one of the trunnion bolts followed by the other.



27. Torque trunnion bolts and lower shock bolt to 13 Nm.

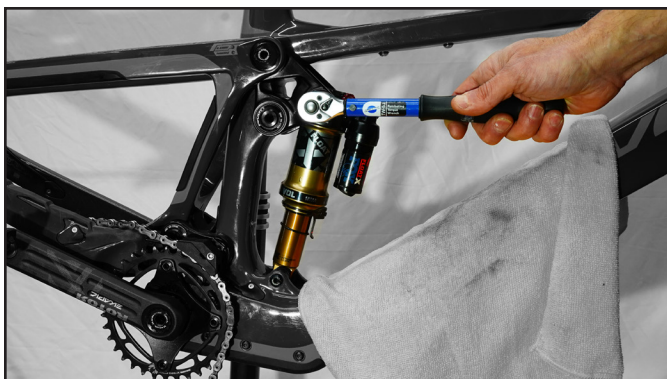

29. Use a towel or rag to wipe any excess Loctite from mounting locations. *Loctite can damage paints and finishes.*

